

PRODUCT SPECIFICATION

MODEL : KT-L19-29



ISSUE DATE : 2006-10-03

Prepared by KORTEK R&D CENTER

KORTEK CORPORATION

RoHS
Compliant
2002/95/EC

Note : Any Modification or Copy of Spec is not allowed without KORTEK's Permission

Revision History

Date	Rev.No	Page	Summary
2006-10-03	Rev0.0	All	1'st issued

Contents

1. Scope	4
2. Feature	4
3. Electrical Specification	
3.1 Input Power	4
3.2 Analog R,G,B Input.....	4
3.3 Display Color	5
3.4 Mode & Timing.....	5~8
4. LCD Panel Specification	
4.1 Screen Specification.....	9~10
4.2 Test Equipment Setup.....	10
4.3 Backlight Unit.....	11
4.4 CIE Coordinates.....	12
4.5 Absolute Maximum Rating.....	13
5. Visual Specification	
5.1 Standard Mode & Display Size.....	13
5.2 Standard Condition.....	13
5.3 Screen Image Stabilizing time.....	13
5.4 H.V Centering	13
5.5 Focus.....	14
5.6 Color Spread	14
5.7 Noise Jitter.....	14
5.8 Residual Image.....	14
5.9 Crosstalk.....	14
6. A/D Board	
6.1 A/D Board connection.....	14~16
6.2 Input signal mode.....	16
7. Inverter Specification	
7.1 Dimension.....	17
7.2 Input Connector.....	17
7.3 Output Connector.....	17
8. User Interface	
8.1 OSD Key MAP.....	18
8.2 OSD Menu Structure.	18
8.3 How to tuning.....	19
8.4 Function(OSD) Menu Actions.....	20
9. Mechanical Specification	
9.1 Outline Dimension (Ass'y)	21
9.2 Outline Dimension (Base)	22
9.3 Outline Dimension (Cover)	23
9.4 Packing Information	24

1. Scope

This document is the specification of 19" TFT-LCD MONITOR for application of Multi –sync.
M190EG02 is a High quality TFT-LCD display solution for industrial display device having RoHS conformity..

2. Features

- Resolution : SXGA (1280 * 1024 @75Hz) Recommend (1280 * 1024 @ 60Hz)
- Image Screen Input Signal : Analog only.
- Flexible Solution of Mechanical Mounting
- On Screen display(OSD)

3. Electrical Specification

3.1 Input Power

3.1.1 Input power is required as

Voltage : DC + 12[V] / 3[A]

Consumption : 30[W] Max

3.1.2 Power Management

Mode	V-Sync	H-Sync	Video	Power Consumption
ON	Pulse	Pulse	Active	Less than 30[W]
Stand By	Pulse	No Pulse	Blanked	Less than 3[W]
Suspend	No Pulse	Pulse	Blanked	Less than 3[W]
Off	No Pulse	No Pulse	Blanked	Less than 3[W]

Transition between state shall not require any manual display adjustment otherwise noted. There is no restriction On any combination of state transition. Zi is recommend that the display wait for about 2 seconds before transition From “on” to avoid unintentionally entering a power saving state during change resolution or frequency.

3.1.3 Analog R,G,B input

Signal : RED, GREEN, BLUE

Polarity : Positive

Level : Analog from 0.714 to 2.5 [V_{p-p}]

Maximum Dot Clock : 135[MHz]

3.1.4 Horizontal Sync

Polarity : (+) or (-) H,V Separate ,Composite sync

Level : TTL Compatible

High : 2.4 ~ 5.0[V]

Low : 0.0 ~ 0.8[V]

Scan Frequency : 15 ~ 80.0[KHz]

3.1.4 Vertical Sync

Polarity : Positive or Negative H&V Separate

Level : TTL Compatible

High : 2.4 5.0 Volt

Low : 0.0 0.8 Volt

Scan Frequency : 55 75[Hz]

3.1.5 Scanning Mode : Non-Interlaced and Interlaced modes

3.3 Display Color : 16,777,216 colors

3.4. Mode & Timing

3.4.1 Preset Mode Timing Chart

Mode Name	VGA	4VESA							
	1	2	3	4	5	6	7	*8	9
Resolution(H)	720	640		800		1024		1280	
(V)	400	480		600		768		1024	
Frequency(H)	31.5	31.5	37.5	37.9	46.9	48.4	60.0	63.9	80.0
(V)	70[Hz]	60[Hz]	75[Hz]	60[Hz]	75[Hz]	60[Hz]	75[Hz]	60[Hz]	75[Hz]

*:Native Mode

3.4.2 Detail Preset Timing

Time Block

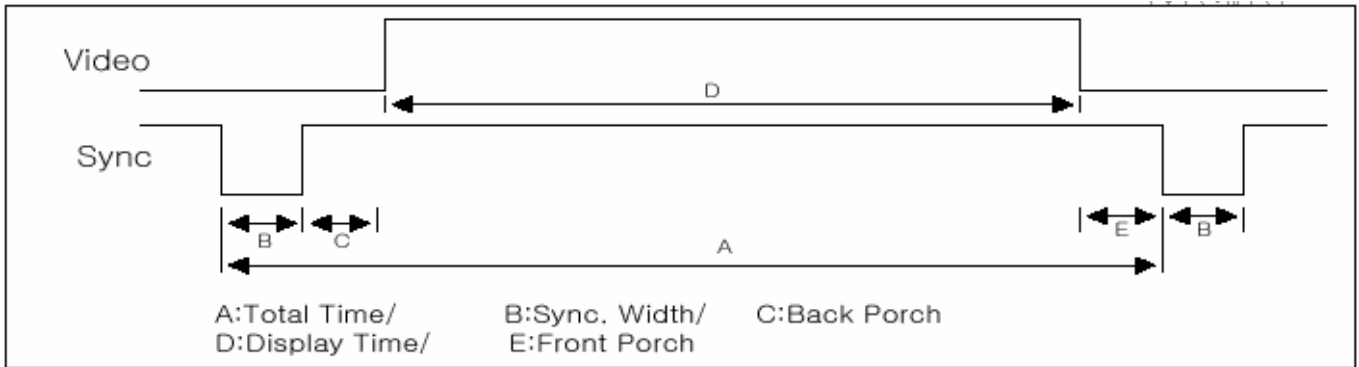

Detail Timing VESA Standard

Description		Mode1	Mode2	Mode3	Mode4	Mode5	Mode6	Mode7	Mode8	Mode9
		720	640		800		1024		1280	
		400	480		600		768		1024	
H O R I Z O N A L	Freq [KHz]	31.649	31.469	37.500	37.879	46.875	48.363	60.023	63.938	79.976
	A [μ s]	31.778	31.778	26.667	26.400	21.333	20.667	16.660	15.630	12.504
	B [μ s]	3.813	3.813	2.032	3.200	1.616	2.092	1.219	1.037	1.067
	C [μ s]	1.907	1.907	3.810	2.200	3.232	2.462	2.235	2.296	1.837
	D [μ s]	25.422	25.422	20.317	20.000	16.162	15.754	13.003	11.852	9.481
	E [μ s]	0.636	0.636	0.508	1.000	0.323	0.369	0.203	0.444	0.119
	Pol	NEG	NEG	NEG	POSI	POSI	NEG	POSI	POSI	POSI
V E R T I C A L	Freq [KHz]	70.087	59.941	75.000	60.317	75.000	60.004	75.029	60.020	75.025
	A [ms]	14.268	16.683	13.333	16.579	13.333	16.666	13.328	16.661	13.329
	B [ms]	0.064	0.064	0.080	0.106	0.064	0.124	0.050	0.047	0.038
	C [ms]	1.112	1.049	0.427	0.607	0.448	0.600	0.466	0.594	0.475
	D [ms]	12.711	15.253	12.807	15.840	12.800	15.880	12.796	16.005	12.804
	E [ms]	0.381	0.317	0.019	0.026	0.021	0.062	0.017	0.016	0.013
	Pol	POSI	NEG	NEG	POSI	POSI	NEG	POSI	POSI	POSI
Pixel Clock [MHz]		28.322	25.175	31.500	40.000	49.500	65.000	78.750	108.000	135.000

3.4.3 Supply Video Timing Chart

Resolution	Rate	Frequency	Frequency	Remark
640 x 350	70 Hz	31.5 kHz	25.175 MHz	
720 x 400	70 Hz	31.5 kHz	28.322 MHz	Text Mode
640 x 480	60 Hz	31.5 kHz	25.175 MHz	n/a
	72 Hz	37.9 kHz	31.500 MHz	VESA
	75 Hz	37.5 kHz	31.500 MHz	VESA
800 x 600	56 Hz	35.1 kHz	36.000 MHz	VESA
	60 Hz	37.9 kHz	40.000 MHz	VESA
	72 Hz	48.1 kHz	50.000 MHz	VESA
	75 Hz	46.9 kHz	49.500 MHz	VESA
1024 x 768	60 Hz	48.4 kHz	65.000 MHz	VESA
	70 Hz	56.5 kHz	75.000 MHz	VESA
	75 Hz	60.0 kHz	78.750 MHz	VESA
1152 X864	75	67.5 KHz	108.00MHz	VESA
1280 x 960	60 Hz	60.0 kHz	108.000 MHz	VESA
1280 x 1024	60 Hz	64.0 kHz	108.000 MHz	VESA
	75 Hz	80.0 kHz	135.000 MHz	VESA

3.4.4 Demand on Special Timing Chart

Gamming Board	Dot Clock [MHz]	H Frequency [KHz]	V Frequency [Hz]	Horizontal				Vertical			
				Total	Disply	Sync Width	Front Porch	Total	Disply	Sync Width	Front Porch
NewCerry / New Fruit	17.4807	15.580	59.240	64.184us	42.218us	5.263us	7.666us	16.880ms	14.506ms	0.064ms	1.284ms
				1122 dot	738 dot	92 dot	134 dot	263 lin	226 lin	1 lin	20 lin
Jungle King / Crazy Bugs	16.7362	15.700	59.924	63.694us	46.725us	5.497us	6.214us	16.687ms	15.223ms	0.064ms	0.701ms
				1066 dot	782 dot	92 dot	104 dot	262 lin	239 lin	1 lin	11 lin
Special 7s	16.8900	15.610	60.270	64.061us	42.747us	5.447us	6.986us	16.591ms	14.350ms	0.064ms	1.153ms
				1082 dot	722 dot	92 dot	118 dot	259 lin	224 lin	1 lin	18 lin
Fruit Genie	15.9739	16.300	59.489	61.349us	42.694us	4.007us	7.512us	16.809ms	14.724ms	0.061ms	0.982ms
				980 dot	682 dot	64 dot	120 dot	274 lin	240 lin	1 lin	16 lin
Big Boss	15.5115	15.700	59.696	63.694us	43.451us	2.966us	7.091us	16.751ms	15.287ms	0.064ms	0.382ms
				988 dot	674 dot	46 dot	110 dot	263 lin	240 lin	1 lin	6 lin
Queen Bee	15.8409	15.500	58.712	64.516us	42.422us	3.156us	9.469us	17.032ms	15.419ms	0.065ms	0.516ms
				1022 dot	672 dot	50 dot	150 dot	264 lin	239 lin	1 lin	8 lin
Pot of Gold / Pace o Matic	20.2943	16.800	60.000	59.523us	46.515us	3.843us	7.490us	16.666ms	15.238ms	0.060ms	0.476ms
				1208 dot	944 dot	78 dot	152 dot	280 lin	256 lin	1 lin	8 lin
Dino Dino	15.9744	15.600	59.316	64.102us	42.443us	1.878us	6.135us	16.858ms	15.385ms	0.064ms	0.705ms
				1024 dot	678 dot	30 dot	98 dot	263 lin	240 lin	1 lin	11 lin

→ You can choose the Game machine on the OSD MENU (left/Top) , To optimize the display

4. LCD Panel Specifications

4.1 Screen Specification

Item	Specification	Unit	Remark	Note
Display Area	376.32 (H) x 301.06 (V)	mm		
Driver Element	a-Si TFT active matrix	Dot		
Display Colors	16,78M (True)	Color		
Number of Pixel	1,280 × 1,024	Pixel		
Pixel Arrangement	RGB Vertical Stripe			
Pixel Pitch	0.294 (per one triad) x 0.294)	mm		
Display Mode	Normally White			
Viewing Angle	80/80/80/80 (U/D/L/R)	Degrees	CR≥10	
Weight	2500	g	Max.	
Contrast Ratio	Typ = 700:1		Center of Screen	
Response Time	Rise = 4.5ms , Fall = 1.5ms		Typ.	
White Luminance	Typ = 300cd/m ²	Cd/m ²	Center of Screen	
Brightness Uniformity	Typ = 80 %	%		
Dimensions	396 (H) x 324 (V) x 17.5 (D) (Typ)	mm		

Vendor Name : AUO

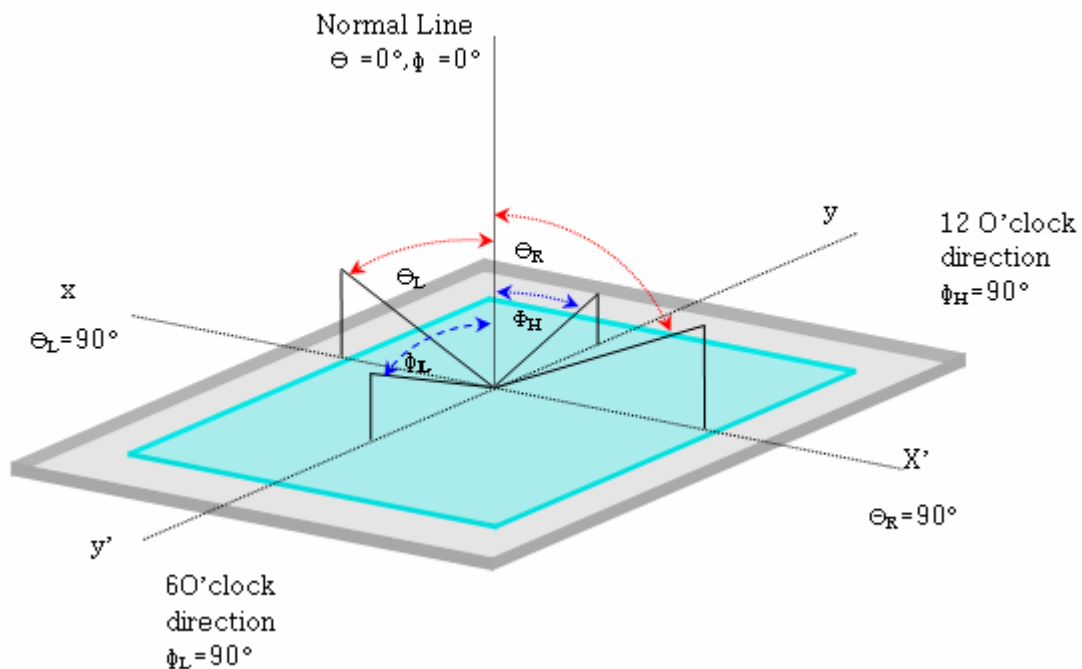

Viewing Angle

Hor.	θ_L	CR \geq 10 (at center of screen)	Right	80	Degree
	θ_R		Left	80	
Ver.	θ_H		Up	80	
	θ_L		Down	80	

Contrast Ratio(CR): Ratio of gray max.(G max.), gray min.(G min.) at the center point of panel.

$$CR = \frac{\text{Luminance of all pixels White}}{\text{Luminance of all pixels black}} = 300 [\text{cd/m}^2]$$

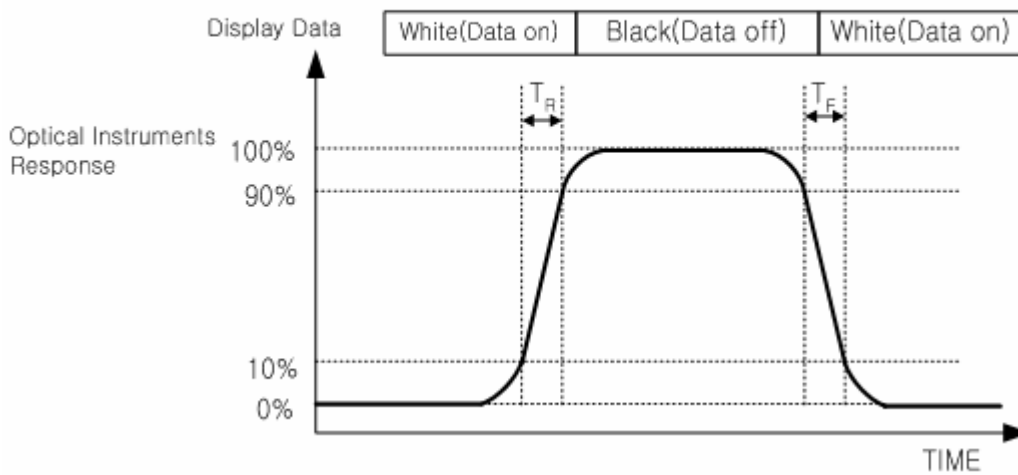

Response Time: Sum of T_R, T_F

Luminance of White (Center of Screen)

$$Y_L = 250 \text{ cd/m}^2 (\text{min.})$$

$$Y_L = 300 \text{ cd/m}^2 (\text{Typ.})$$

Optical characteristics measurement

4.2 Test Equipment Setup

After stabilizing and leaving the panel alone at a given temperature for 30 min, the measurement should be executed. Measurement should be executed in a stable, windless, and dark room. 30 min after lighting the back-light. This should be measured in the center of screen. A single lamp current: 6.5[mA] Environment condition : $T_a = 25 \pm 2 [\quad]$

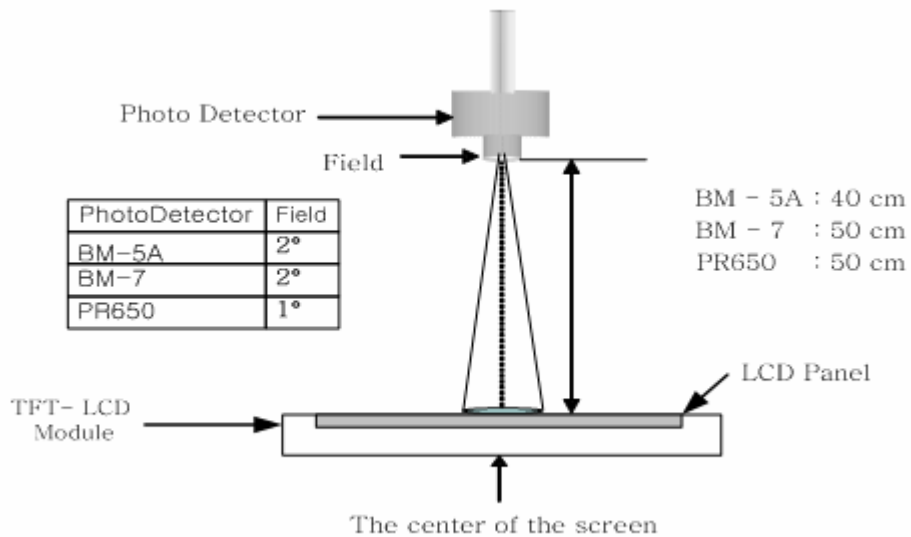

Brightness uniformity(9 point)

$$Buni = 100 * (B_{max} - B_{min}) / B_{max}$$

B_{max} : Maximum brightness, B_{min} : Minimum brightness

Definition of test point

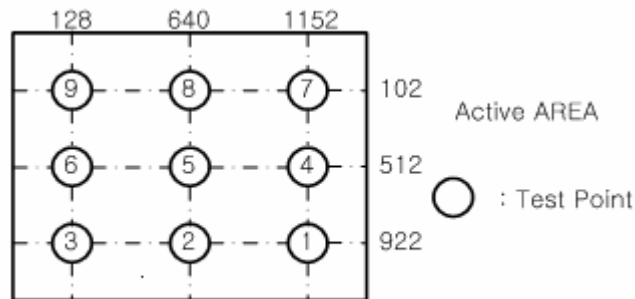

4.3 Back Light Unit

The Back-light system is an edge-lighting type with 2 dual CCFTs (Cold Cathode Fluorescent Tube).

Item	Symbol	min	Typ.	Max	Unit
Lamp Current	I_L	7.0	7.5	8.0	mA_{RMS}
Lamp Voltage	V_L	-	653	796	V_{RMS}
Freq.	f_L	40	60	80	KHz
Operating Life Time	H_r	40,000	50,000	-	Hour
Startup Voltage	V_s	1300(25) 1690(0)	-	-	V_{RMS}

4.4 CIE Coordinates (Color Chromaticity)

Item	Color chromaticity (CIE 1391)	
	X(Typ.)	Y(Typ.)
Red	0.640±0.03	0.340 ±0.03
Green	0.290 ±0.03	0.610 ±0.03
Blue	0.140 ±0.03	0.070 ±0.03
White	0.310 ±0.03	0.330 ±0.03

4.5 Absolute Maximum Rating

4.4.1 Absolute rating of environment

ITEM	Symbol	Min	Max	Unit	Note
Storage temperature	T _{STG}	-20	60		(1)
Operating temperature (Surface of Glass temperature)	T _{OPR}	0	50		(1)
Shock (non - operation)	S _{NOP}	-	50	G	(2),(4)
Vibration (non – operating)	V _{NOP}	-	1.5	G	(3),(4)

Note (1) Temperature and relative humidity range are shown in the figure below.

90% RH Max. (40 ≥ Ta)

(2) 11ms, sine wave, one time for ±X, ±Y, ±Z axis.

(3) 10-300Hz, Sweep rate 10min, 30min for X, Y, Z axis.

(4) At testing Vibration and Shock, the fixture in holding the Module to be tested have to be hard and rigid enough so that the Module would not be twisted or bent by the fixture.

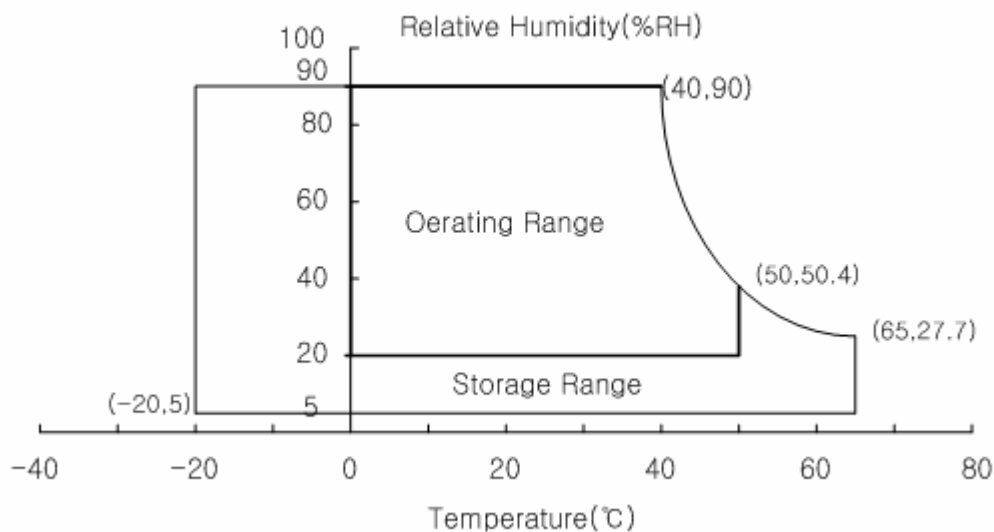

5. Visual Specification

5.1. Standard Mode & Display Size

Item	Specification	Note
Standard Mode	SXGA 1280 x 1024 @ 60 [Hz]Resolution	Recommend Mode
Display Size	376.32 (H) x 301.06 (V)	Panel Active Visual Size

5.2. Standard Condition

Item	Specification	Note
Warm up Time	30 minutes after lighting	
Panel Face	None	
AC / DC Adapter	100 ~ 220Vac to 12Vdc	

5.3. Screen image Stabilizing Time

Item	Specification	Note
Video Display Time	After turning power switch on, within 15 seconds	
Display Stability time	After turning power switch on, within 30 seconds	
AC input Voltage Stability	All specifications should be within 10% at 100~240V.	
Environments stability	All specifications should be within 2% at the operating temperature	

Note) All kinds of specification should be satisfied after 30 minutes from turning power switch on.

5.4. H & V Centering : 1280 ×1024 , 60Hz

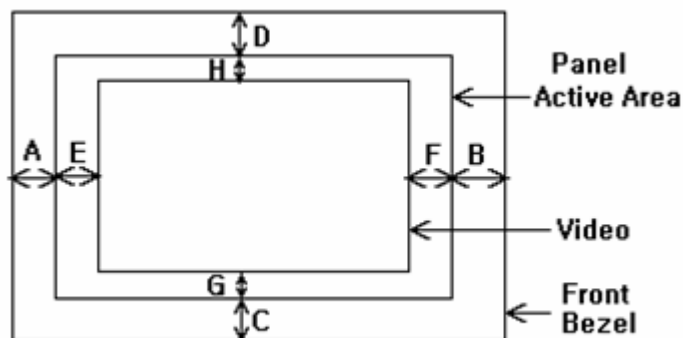

$$|A-B| \text{ and } |C-D| \leq 1.0[\text{mm}], |E-F| \text{ and } |G-H| \leq 1.0[\text{mm}]$$

6. A/D Board

A/D Board

This board is main controller board and has following functions.

- Analog to Digital Conversion (R,G,B Gain Control)
- Scaling: input signal to fit Panel's resolution.
- Inverter Power control.
- DC to DC conversion to supply various power to each circuit

6.1 A/D Board connection

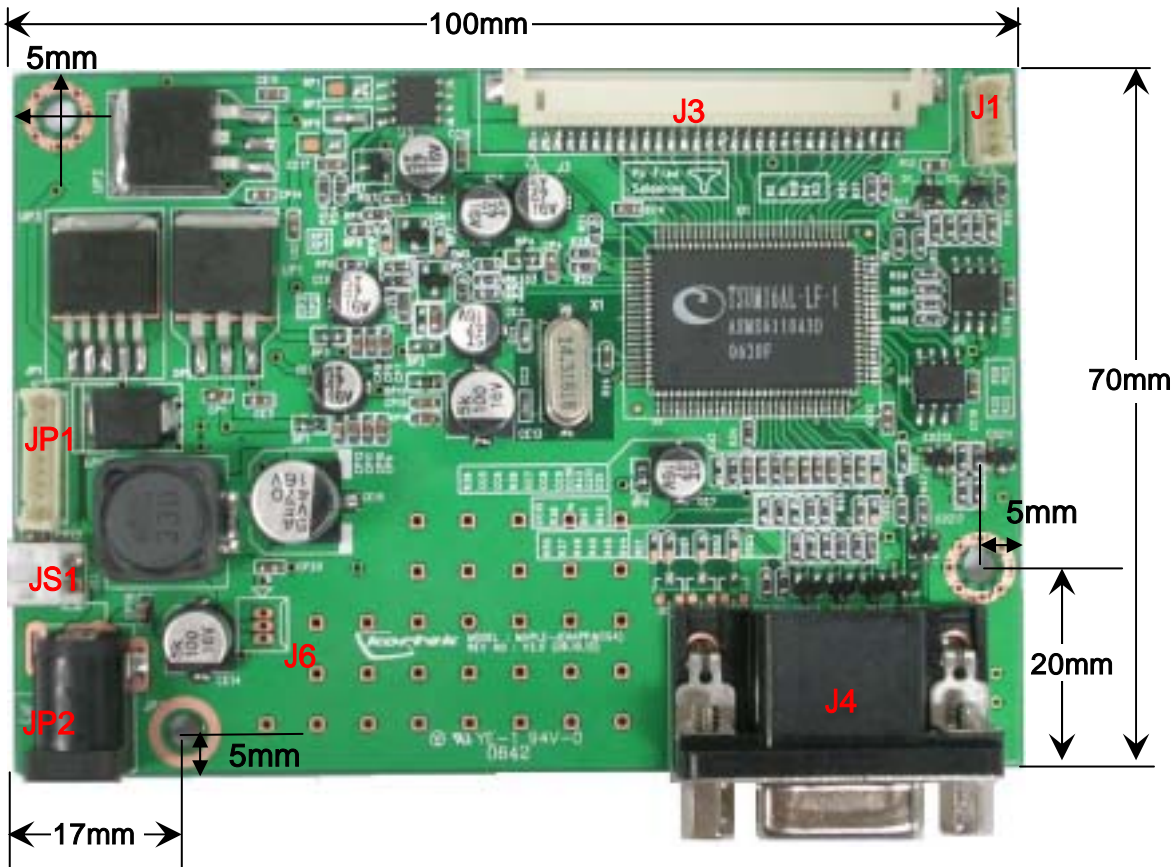

6.1.1 Description

No	Symbol	Description
1	J1	OSD KEY
2	J3	LVDS_OUT (Dual & Single)
3	J4	Analog (R,G,B) Input / ISP (Debugger)
4	J6	Touch Power
5	JP1	Inverter
6	JP2	Power Input (+12V)
7	JS1	Reserved connector for touch controller's power (+12V)

6.1.2 Connection Details

No	Symbol		description	Parts Number	Manufacture
1	J1	OSD_KEY	KeyPad(1.27P_5PIN)	12512WS-5A00 STR	YEONHO
2	J3	LVDS_OUT	Wafer LVDS Panel 30Pin (SMT, R/A)	12507WR-30PIN	YEONHO
3	J4	Analog RGB_In	Connector, D-Sub 15PIN Female (DIP, R/A)		
4	J6	Touch Power	Touch Power(1.27P/3PIN)	12512WS-3A00 STR	YEONHO
5	JP1	Inverter Power & Control	Inverter (1.27/9PIN)	12512WS-9A00 STR	YEONHO
6	JP2	ADAPTER IN	DC Jack 2.5PI, ANGLE		

6.1.3 J4 (Analog R,G,B In)

Pin	Function	Pin	Function	Pin	Function
1	Red	6	Red ground	11	Reserved
2	Green	7	Green ground	12	DDC SDA
3	Blue	8	Blue ground	13	HSYNC (horizontal sync) Composit Sync Input (CGA)
4	Reserved	9	+5V DC	14	VSYNC (vertical sync)
5	Ground	10	Sync Ground	15	DDC SCL

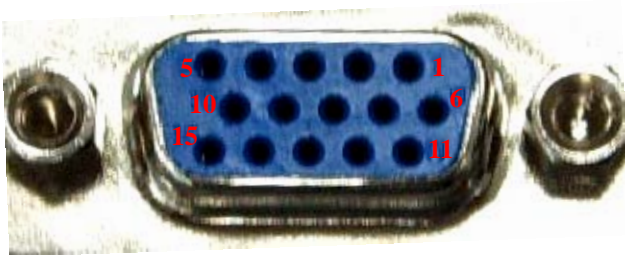

6.1.4 J2 Power In (Adapter)

Pin	Signal	Pin	Signal	Pin	Signal
1	+12V	2	GND	3	GND

6.1.5 JP1 Inverter Control

Pin	Signal	Pin	Signal	Pin	Signal	Pin	Signal	Pin	Signal
1	OPEN	2	INV ON/OFF	3	A_DIM	3	GND	4	GND
5	GND	6	+12V	7	+12V	8	+12V		

6.1.6 J3: LVDS_OUT

Pin	Signal	Pin	Signal	Pin	Signal	Pin	Signal	Pin	Signal
1	POWER	7	TXE0M	13	GND	19	TXO0P	25	TXO2P
2	POWER	8	TXE0P	14	TXECKM	20	GND	26	TXOCKM
3	POWER	9	TXE1M	15	TXECKP	21	TXO1M	27	TXOCKP
4	NC	10	TXE1P	16	TXE3M	22	TXO1P	28	TXO3M
5	NC	11	TXE2M	17	TXE3P	23	GND	29	TXO3P
6	NC	12	TXE2P	18	TXO0M	24	TXO2M	30	GND

6.1.7 J1 OSD_Key

Pin	Signal	Pin	Signal	Pin	Signal	Pin	Signal	Pin	Signal
1	KEY INPUT A	2	KEY INPUT B	3	LED R	4	LED G	5	GND

6.2 Input signal mode

6.2.1 Input signal Interface

ANALOG RGB(ADC) interface

max 165MHz sampling rate support UXGA/60Hz

analog R'B'G' (3D space cube coordinate system) known as SOG (Sync-on-Green)

7. Inverter Specification

This board generates AC 750 [V_{RMS}] from DC +12[V], and This AC used to turn on CCFL (Cold Cathode Fluorescent Lamp).

7.1 Dimension

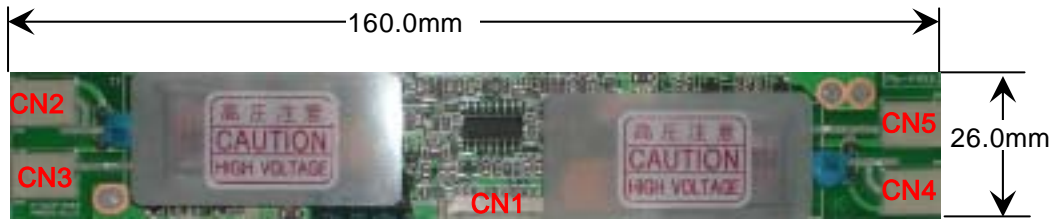

7.2 Input Connector

CN1 : 12505 WR-12A00 (Yeon Ho)

Pin No	Symbol	Description
10, 11, 12	Vin	Input : +12V
1, 3, 5, 6, 8, 9	GND	GND
2	Dim control	0V: Max Brightness, 5V: Min Brihtness
4	On/ Off	Lamp Turn on & Off (5V: On, 0V: Off)

7.3 Output Connector : CN2, CN3, CN4, CN5

Pin No.	Symbol	Description
1	Lamp H1	High Voltage
2	Lamp L1	Return (Low Voltage)

- **Caution:**

When output connector is checked. The power should be turn off, Otherwise maybe be shocked electrically.

8 User Interface

8.1 OSD Key MAP



8.1.1 Key Functions.

No	Button	Action
1.	Power	Power on and off
2.	LED	Indicator
3.	Menu/Exit	1. Enable / Disable OSD Menu. 2. Return to previous Menu
4.	Left / Decrease	1. Move down menu to select. 3. Brightness Hot Key 2. Decrease the value
5.	Right / Increase	1. Move up menu to select 2. Increase the value 3. Contrast Hot key
6.	Auto	Automatically Adjust Geometric, Position, Phase & Color to optimal condition.
7.	Select	Select current OSD Menu

8.2 OSD Menu Structure.

Picture Menu	Color Menu
OSD Menu	Misc Menu

8.3 How to tuning

For example: To be controlled the Contrast value.

Step 1. Push the Menu button and then OSD menu is shown on the screen.

Step 2. Move up or down to picture menu with Left or Right button.
Push the select button. And then top menu will be marked with red color.



Step 3. Move up or down to contrast menu with Left or Right button.
The position of red mark indicates the current state.

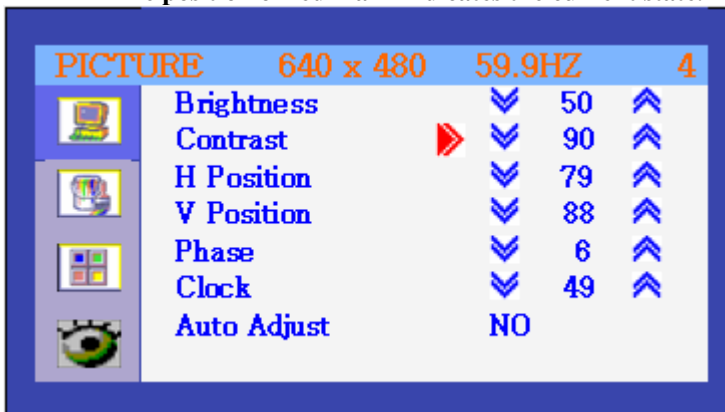



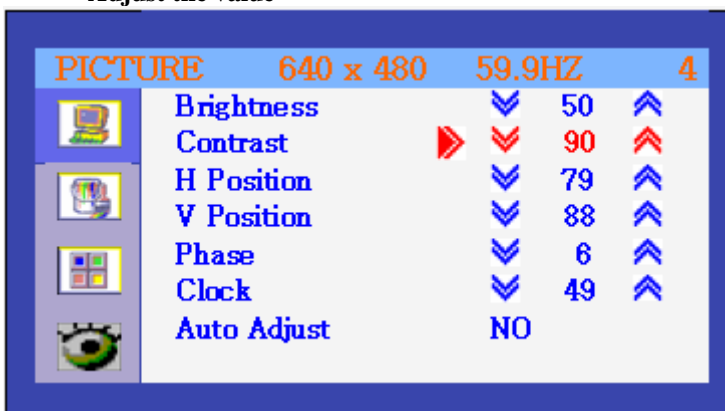

Step 4. Push the select button. The value will be changed red color.
Adjust the value



Shortcut

Menu button → move to picture(Main menu) → Select button → move to contrast menu → select → Adjust

8.4 Function(OSD) Menu Actions

Main Menu	Sub-Menu	Action
PICTURE 	Contrast	Tuning menu of Screen's Contrast.
	Brightness	Tuning menu of Screen's Brightness.
	H-Position	Tuning menu of Screen's H Position.
	V-Position	Tuning menu of Screen's V Position.
	Phase	Tuning menu of Screen's Phase.
	Clock	Tuning menu of Screen's Clock.
	Auto Adjust	Automatically Adjust Screen's Geometric, Position, Phase to Optimal Condition.
COLOR 	Color Temp	Tuning menu of Screen's Color Temp.
	Red	Tuning menu of Screen's Red Gain.
	Green	Tuning menu of Screen's Green Gain.
	Blue	Tuning menu of Screen's Blue Gain.
	Auto Color	Automatically Adjust Screen Color/Input Gain/Input Offset
OSD 	Osd H-Posi	Tuning menu of OSD H Position
	Osd V-Posi	Tuning menu of OSD V Position.
	Osd Timer	Selection menu of OSD Display Time.
	Transparency	Selection menu of OSD Halftone Time.
MISCELLANEOUS 	Language	Selection menu of Language (English, Korea, Spanish, French, German)
	Recall	Initialize eeprom data (Return default Data)
	Input Select	Selection menu of Input Source
	Information	Information about Monitor.

9. Mechanical Specification
9.1 Outline Dimension (ASS'Y)

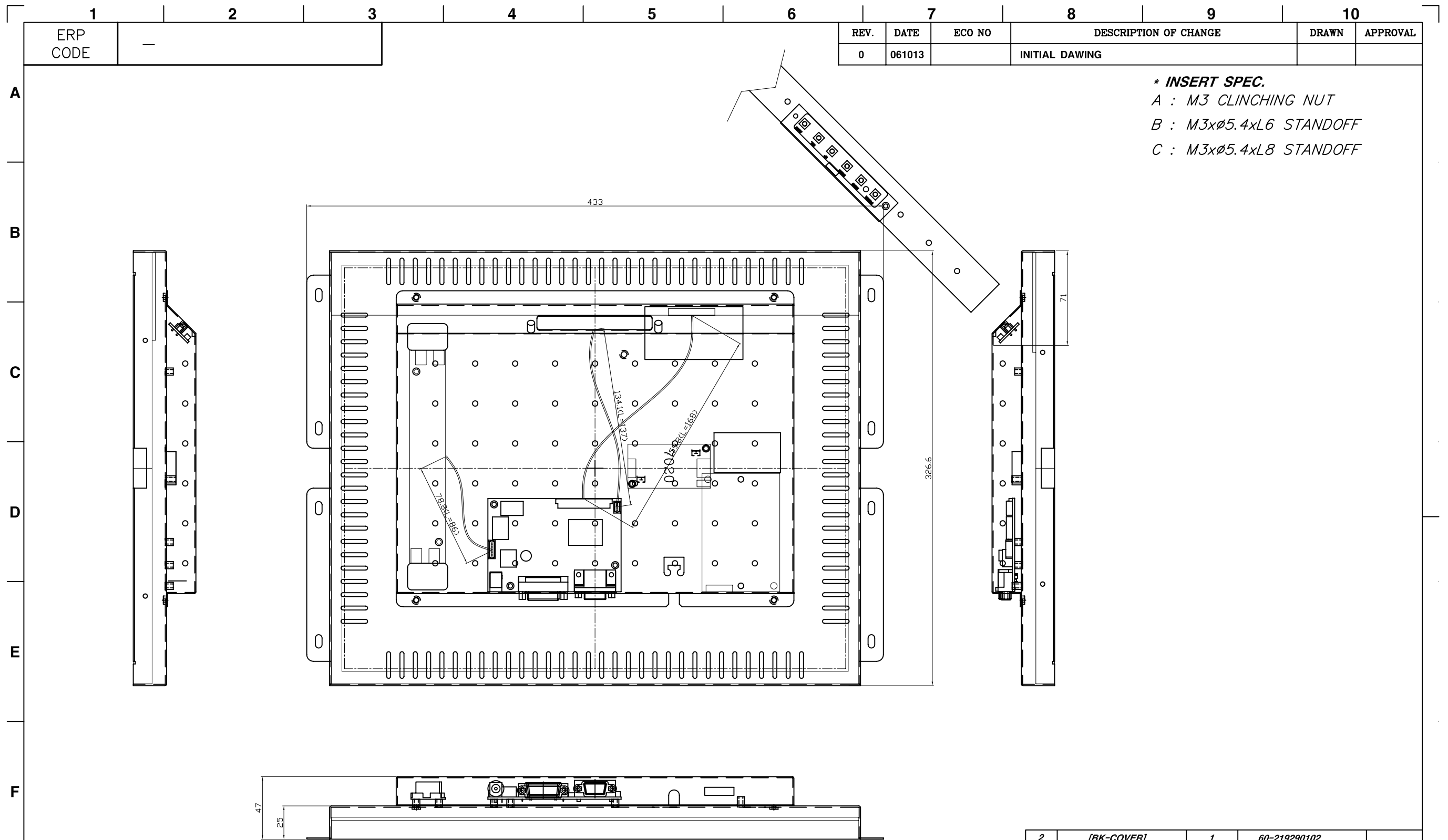

REV.	DATE	ECO NO	DESCRIPTION OF CHANGE	DRAWN	APPROVAL
0	061013		INITIAL DAWING		

*** INSERT SPEC.**
 A : M3 CLINCHING NUT
 B : M3xØ5.4xL6 STANDOFF
 C : M3xØ5.4xL8 STANDOFF

- NOTE**
1. Remove all sharp edges
 2. No harmful on the surface
 3. No inscribed ROUND, FILLET : R3
 4. Angular tolerance ±0.5°

THIRD ANGLE PROJECTION	
DIMENSION TOLERANCES	
LENGTH	HOLE DIAMETERS
UNDER 49 ±0.1	UNDER 3.81 ±0.13
5.0 ~ 20.9 ±0.15	3.81 ~ 6.35 ±0.13
21.0 ~ 50.9 ±0.2	6.36 ~ 12.70 ±0.13
51.0 ~ 200.9 ±0.4	12.70 OVER ±0.25
201.0 ~ 500.0 ±0.6	ANGLE
500.0 OVER ±1.0	±0.3°

NO.	DESCRIPTION	Q'TY	DWG NO.	REMARK																
2	[BK-COVER]	1	60-219290102																	
1	[BK-BASE]	1	60-219290101																	
<table border="1"> <thead> <tr> <th>DATE</th> <th>NAME</th> <th>TITLE</th> <th>SCALE</th> </tr> </thead> <tbody> <tr> <td>061013</td> <td>N.H.CHOI</td> <td>FRAME TFT LCD 19" EG02_MJ HAPP [ASS'Y]</td> <td>1:1</td> </tr> <tr> <td>061013</td> <td>S.J.PARK</td> <td>REF.</td> <td></td> </tr> <tr> <td>061013</td> <td>H.T.KIM</td> <td>DWG.NO</td> <td>60-219290100</td> </tr> </tbody> </table>					DATE	NAME	TITLE	SCALE	061013	N.H.CHOI	FRAME TFT LCD 19" EG02_MJ HAPP [ASS'Y]	1:1	061013	S.J.PARK	REF.		061013	H.T.KIM	DWG.NO	60-219290100
DATE	NAME	TITLE	SCALE																	
061013	N.H.CHOI	FRAME TFT LCD 19" EG02_MJ HAPP [ASS'Y]	1:1																	
061013	S.J.PARK	REF.																		
061013	H.T.KIM	DWG.NO	60-219290100																	
MATERIAL		UNIT	SHEET																	
ASS'Y		mm	1/1																	

9.2 Outline Dimension (Base)

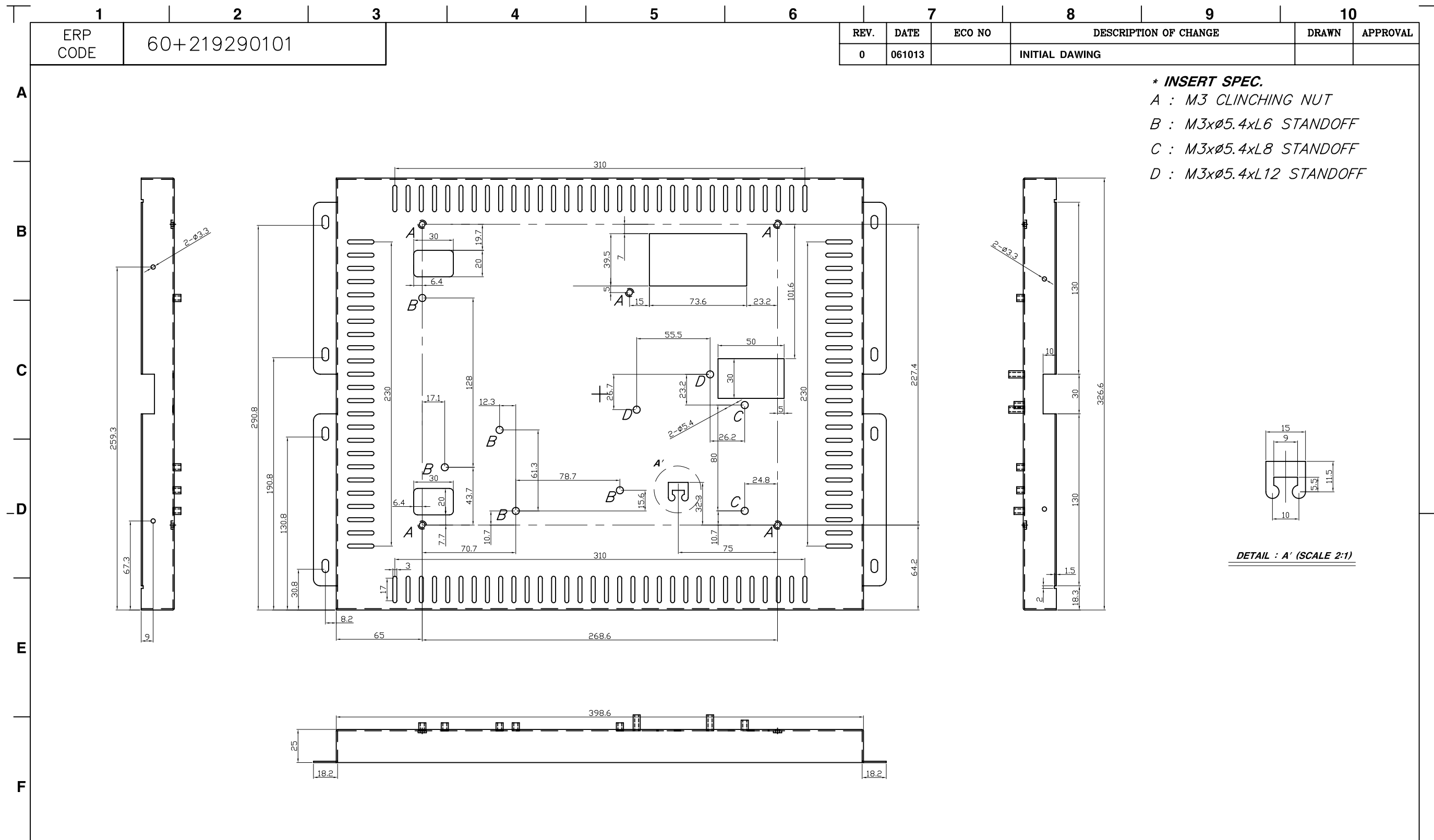

REV.	DATE	ECO NO	DESCRIPTION OF CHANGE	DRAWN	APPROVAL
0	061013		INITIAL DAWING		

*** INSERT SPEC.**
 A : M3 CLINCHING NUT
 B : M3xØ5.4xL6 STANDOFF
 C : M3xØ5.4xL8 STANDOFF
 D : M3xØ5.4xL12 STANDOFF

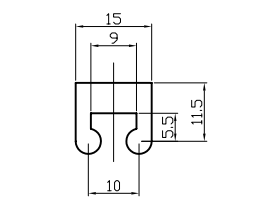

NOTE

1. Remove all sharp edges
2. No harmful on the surface
3. No inscribed ROUND, FILLET : R3
4. Angular tolerance ±0.5°

THIRD ANGLE PROJECTION		DIMENSION TOLERANCES	
LENGTH	HOLE DIAMETERS		
UNDER 4.9 ±0.1	UNDER 3.81 ±0.13		
5.0 ~ 20.9 ±0.15	3.81 ~ 6.35 ±0.13		
21.0 ~ 50.9 ±0.2	6.36 ~ 12.70 ±0.13		
51.0 ~ 200.9 ±0.4	12.70 OVER ±0.25		
201.0 ~ 500.0 ±0.6	ANGLE		
500.0 OVER ±1.0	±0.3°		

NO.	DESCRIPTION	Q'TY	REMARK
1	[BK-BASE]	-	60-219290101
	DATE	NAME	TITLE
DES.G	061013	N.H.CHOI	FRAME TFT LCD
CHEC.	061013	S.J.PARK	19" EG02_MJ HAPP
APP.	061013	H.T.KIM	[BK-BASE]
	REF.	DWG.NO	60-219290101
		MATERIAL	UNIT
		GI 1T	mm
			SHEET
			1/1



9.3 Outline Dimension (Cover)

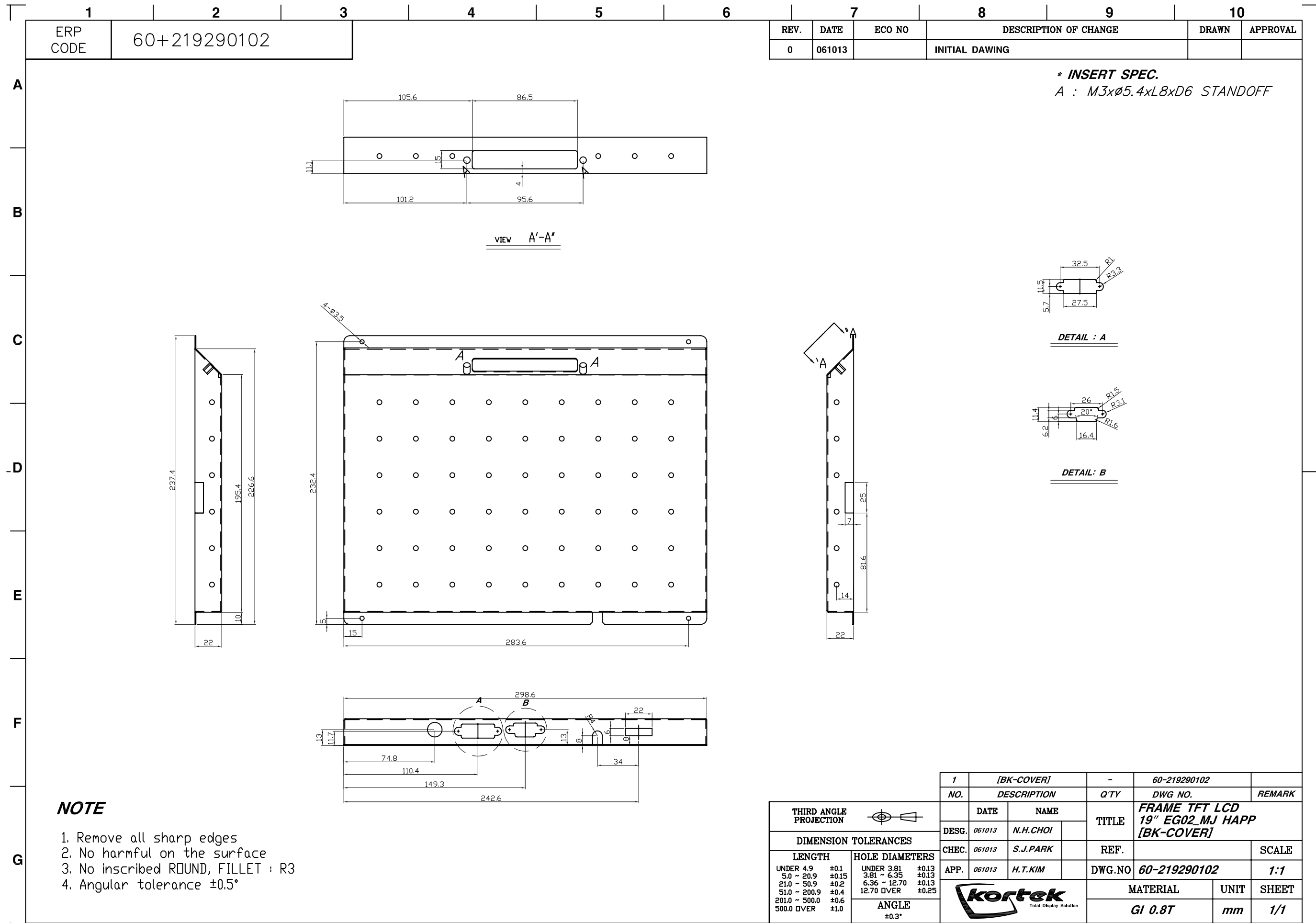

9.4 Packing Information

T.B.D